

# SERVO VALVES PILOT OPERATED

## FLOW CONTROL VALVE WITH ANALOG INTERFACE

G761/-761 SERIES  
ISO 10372 SIZE 04

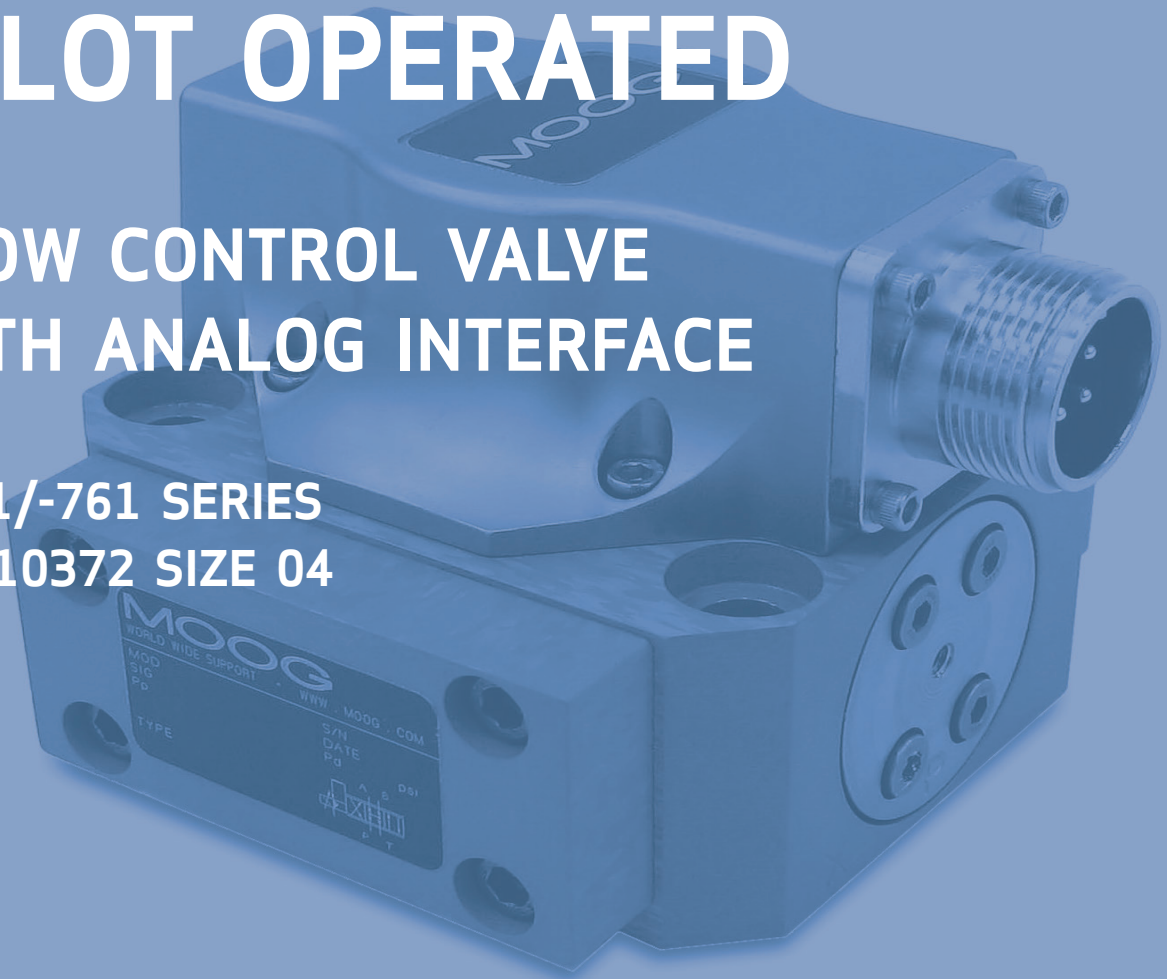

Rev. L, September 2021

HIGH PERFORMANCE, TWO-STAGE DESIGN PROVIDING  
FLOW CONTROL IN A SIMPLE, RUGGED, DEPENDABLE,  
LONGLIFE DESIGN

Whenever the highest levels of motion control performance and design flexibility are required, you'll find Moog expertise at work. Through collaboration, creativity and world-class technological solutions, we help you overcome your toughest engineering obstacles, enhance your machine's performance, and help take your thinking further than you ever thought possible.

INTRODUCTION.....	2
Product Overview .....	3
Description of Operation .....	5
TECHNICAL DATA .....	6
G761/-761 Series Servo Valves.....	6
Installation Drawing.....	11
Mounting Requirements.....	12
Electrical Connection.....	13
BACKGROUND .....	14
Flow Calculation .....	14
ORDERING INFORMATION.....	15
Accessories and Spare Parts.....	15
Related Products .....	16
About Moog.....	17
Ordering Code .....	19

---

This catalog is for users with technical knowledge. To ensure all necessary characteristics for function and safety of the system, the user has to check the suitability of the products described herein. The products described in this document are subject to change without notice. In case of doubt, please contact Moog.

Moog is a registered trademark of Moog Inc. and its subsidiaries. All trademarks as indicated herein are the property of Moog Inc. and its subsidiaries. For the full disclaimer refer to [www.moog.com/literature/disclaimers](http://www.moog.com/literature/disclaimers).

For the most current information, visit [www.moog.com/industrial](http://www.moog.com/industrial) or contact your local Moog office.

## PRODUCT OVERVIEW

The G761/-761 Series Flow Control Servo Valves are throttle valves for 3-way and preferably 4-way applications. They are a high performance, 2-stage design that covers the range of rated flows from 0.5 to 75 l/min (0.125 to 19.5 gpm) at 35 bar (500 psi) valve pressure drop per spool land.

The design is simple and rugged for dependable, long life operation. The pilot stage is comprised of a symmetrical, nozzle-flapper torque motor. The output stage includes a 4-land sliding spool, precision ground to a bushing for optimal performance. A carbide tipped feedback wire provides mechanical feedback of the spool position to the torque motor. The carbide ball on the end of the feedback wire ensures high accuracy, reliable operation and long service life. All of our Servo Valves are known for high accuracy and reliable operation even in the harshest industrial applications.

These valves are suitable for electrohydraulic position, speed, pressure or force control systems with high dynamic response requirements.

The G761/-761 Series is one of the most versatile servo valves suitable for a broad range of applications. It is the latest version of the famous 760 series that incorporates about 70 years of Moog design expertise.

<b>Valve design</b>	2-stage, with spool and bushing and dry torque motor
<b>Mounting pattern</b>	ISO 10372-04-04-0-92
<b>Maximum operating pressure - ports P, A, B and X</b>	<ul style="list-style-type: none"> <li>Aluminium body: 315 bar (4,500 psi)</li> <li>Steel body: 350 bar (5,000 psi)</li> </ul>
<b>Maximum operating pressure - port T</b>	210 bar (3,000 psi)
<b>Pilot valve</b>	Nozzle flapper
<b>Rated flow at <math>\Delta p_N</math> 35 bar/spool land (500 psi/spool land)</b>	0.5 to 75 l/min (0.125 to 19.5 gpm)
<b>Step response time for 0 to 100 % stroke</b>	Standard: < 8 ms High: < 6 ms Very high: < 4 ms



Intrinsically safe and explosion proof valve versions are available for use in potentially hazardous environments. Specific models are certified to FM, ATEX, CSA, TIIS and IECEx standards. Contact Moog for details.

### Documents

Part name	Description	Remark	Moog part number
Catalog	G761/-761 series general information	Note: Visit <a href="http://www.moog.com/industrial">www.moog.com/industrial</a>	CDL6642
Manual	G761/-761		CDS6673
	G761K/-761K intrinsically safe Series		CDS6769
Installation drawing	G761/-761 Series global design		CB59420
	G761K/-761K Series, 2-coils		CA33637
	G761K/-761K Series, 3-coils		CA28051

## FEATURES AND BENEFITS

Features	Benefits
100 % factory tested to ensure critical specification performance	Ensures smooth and easy startup, reduces downtime and insures long life in critical industrial applications
2-stage design	Enables high machine performance, faster cycle times and greater accuracy – all resulting in higher productivity
Dual coil torque motor	Redundancy for high reliability
Dual precision nozzles in torque motor	Precision flow control and predictability
Dry torque motor design	Eliminates potential contamination issues in the air gaps of the torque motor that could cause machine downtime
Hardened 440C bushing and spool	Provides for high life, wear resistance when used in the harsh environments; provides for low sliding friction during use
Carbide, ball-in-hole feedback mechanism	Extends lifetime of servo valve when compared to slotted spool and sapphire ball designs
Emergency fail-safe positioning	Most valves are set up to return to a fail-safe position when the command signal is interrupted or eliminated
Field replaceable pilot stage filter	Enables preventive maintenance in the field, saving precious machine downtime and service costs
External null bias adjustment	Enables technicians to manually adjust the null bias of the valve to adapt to the conditions of the machine (see section “Null Flow Adjustment”). This feature provides a simple adjustment to machine performance without the need to adjust a controller.
Standard field configurable 5th port for separate pilot supply	Provides for the precise control of low pressure applications and allows adaptability in service.
Many customizable options available	High adaptability to many applications.
Compliant to SAE-ARP-490 Valve Design Standard	Electrohydraulic Servo Valves according to this ARP standard are applicable to fluid power systems in all types of flight vehicles, and it is applicable to Military, Civil and Space design/certification standards
Port pattern per ISO Standard	Readily available mounting manifolds

## DESCRIPTION OF OPERATION

The G761/-761 Series Flow Control Servo Valve consists of a polarized electrical torque motor and two stages of hydraulic power amplification. The motor armature extends into the air gaps of the magnetic flux circuit and is supported in this position by a flexure tube member. The flexure tube acts as a seal between the electromagnetic and hydraulic sections of the valve. The 2 motor coils surround the armature, one on each side of the flexure tube.

The flapper of the first stage hydraulic amplifier is rigidly attached to the midpoint of the armature. The flapper extends through the flexure tube and passes between 2 nozzles, creating two variable orifices between the nozzle tips and the flapper. The pressure controlled by the flapper and nozzle variable orifice is fed to the end areas of the second stage spool.

The second stage is a conventional four-way spool design in which output flow from the valve, at a fixed valve pressure drop, is proportional to spool displacement from the null position. A cantilever feedback spring is fixed to the flapper and engages a hole in the center of the spool. Displacement of the spool deflects the feedback spring which creates a force on the armature/flapper assembly.

Input signal induces a magnetic charge in the armature and causes a deflection of the armature and flapper. This assembly pivots about the flexure tube and increases the size of one nozzle orifice and decreases the size of the other.

The differential pressure created by this action causes spool motion. The resulting spool displacement induces a linear force in the feedback wire which opposes the original input signal torque. Spool movement continues until the feedback wire force equals the input signal force.

### Electro-hydraulic Servo Valve Cut-away

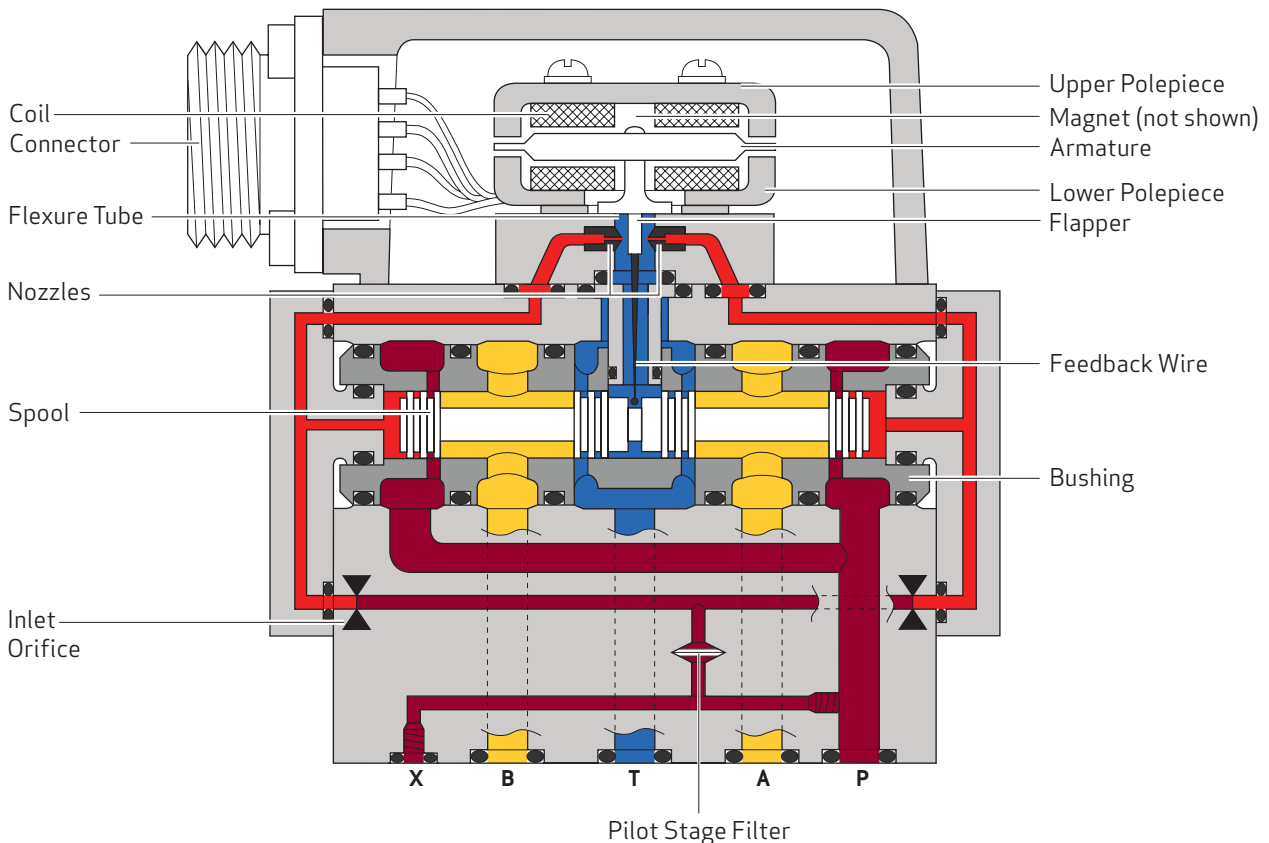

# G761/-761 SERIES SERVO VALVES

## General Technical Data

<b>Valve design</b>	2-stage mechanical feedback, with bushing and spool
<b>Pilot valve</b>	Nozzle flapper
<b>Mounting pattern</b>	ISO 10372-04-04-0-92
<b>Installation position</b>	Any position, fixed or movable
<b>Weight with steel body</b>	1.7 kg (3.8 lb)
<b>Weight with aluminium body</b>	1.0 kg (2.2 lb)
<b>Storage temperature range</b>	-40 to +60 °C (-40 to +140 °F)
<b>Ambient temperature range</b>	-29 to +135 °C (-20 to +275 °F) <sup>1)</sup>
<b>Vibration resistance</b>	30 g, 3 axis, 10 Hz to 2 kHz
<b>Shock resistance</b>	30 g, 3 axis

1) Option available for higher temperature ranges up to 400 °F.

## Hydraulic Data <sup>1)</sup>

<b>Maximum operating pressure port P, X, A, B</b>	<ul style="list-style-type: none"> <li>Aluminium body: 315 bar (4,500 psi)</li> <li>Steel body: 350 bar (5,000 psi)</li> </ul>						
<b>Maximum operating pressure port T</b>	Static: same as P port. Normal operating: 70 bar (1,000 psi).						
<b>Minimum operating pressure</b>	14 bar (200 psi)						
<b>Rated flow at <math>\Delta p_N</math> 35 bar (500 psi)/spool land</b>	0.5 to 2 l/min (0.13 to 0.53 gpm)	4 l/min (1.1 gpm)	10 l/min (2.5 gpm)	19 l/min (5 gpm)	38 l/min (10 gpm)	57/63 l/min (15.1/16.6 gpm)	75 l/min (19.8 gpm)
<b>Maximum flow <math>Q_{max}</math></b>	104 l/min (27.5 gpm)						
<b>Typical leakage</b>	1.0 l/min (0.26 gpm)		1.5 l/min (0.4 gpm)	2.1 l/min (0.55 gpm)			
<b>Maximum total leakage (axis cut)</b>	1.2 l/min (0.31 gpm)		2 l/min (0.53 gpm)	2.8 l/min (0.74 gpm)	3 l/min (0.79 gpm)		3.3 l/min (0.87 gpm)
<b>Pilot flow</b>	0.45 l/min (0.12 gpm) to 0.80 l/min (0.21 gpm)						
<b>Null adjust authority <sup>2)</sup></b>	75 %			60 %	25 %	15 %	10 %
<b>Hydraulic fluid</b>	Mineral oil based fluids according to DIN 51524 parts 1 to 3 and ISO 11158. Other fluids upon request.						
<b>Seal material</b>	FKM (fluorocarbon) 90 Shore, EPR (ethylene-propylene copolymer) 90 Shore, others upon request						
<b>Hydraulic fluid temperature range</b>	-29 to +135 °C (-20 to +275 °F)						
<b>Recommended viscosity range at 38 °C (100 °F)</b>	15 to 100 mm <sup>2</sup> /s (cSt)						
<b>Recommended cleanliness class as per ISO 4406 for functional safety</b>	17/14/11						
<b>Recommended cleanliness class as per ISO 4406 for longer service life</b>	15/13/10						
<b>Recommended filter rating for functional safety</b>	$\beta_{10} \leq 75$ (10 $\mu$ m absolute)						
<b>Recommended filter rating for longer service life</b>	$\beta_5 \leq 75$ (5 $\mu$ m absolute)						

1) Measured at 210 bar (3,000 psi) pilot or operational pressure, oil viscosity 32 mm<sup>2</sup>/s and oil temperature +40 °C (+104 °F)

2) For standard configuration. Optional magnetic null offers approximately 10 % adjustment.

## G761/-761 SERIES SERVO VALVES

### Typical Static and Dynamic Data <sup>1)</sup>

<b>Step response time for 0 to 100 % stroke</b>	Standard: < 16 ms High: < 7 ms Very high: < 4 ms
<b>Threshold, typical</b>	≤ 0.5 %
<b>Hysteresis, typical</b>	≤ 3.0 %
<b>Null shift per ΔT = 55 °C (131 °F)</b>	≤ 2.0 %
<b>Standard flow tolerance</b>	±10 %
<b>Pressure null shift with 1,000 psi change</b>	< 2 %

1) Measured at 210 bar (3,000 psi) pilot or operational pressure, oil viscosity 32 mm<sup>2</sup>/s and oil temperature +40 °C (+104 °F)

## STANDARD RESPONSE

A larger spool diameter provides greater driving force and higher maximum flow rate. The low flow pilot stage (F) ensures a uniform pressure output. A high flow pilot stage (G) is available for improved dynamics.

Type	-3 dB	90 deg phase lag	Step response
S04/S10/S19..F	80 Hz	145 Hz	6 ms
S38..F	60 Hz	115 Hz	10 ms
S57/S63..F	45 Hz	100 Hz	16 ms
S57/S63..G	80 Hz	125 Hz	7 ms
S75 upon request			

### Typical Characteristic Curves

S04/S10/S19..F

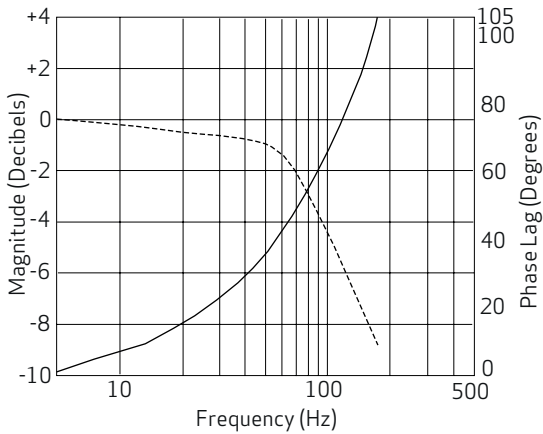

S38..F

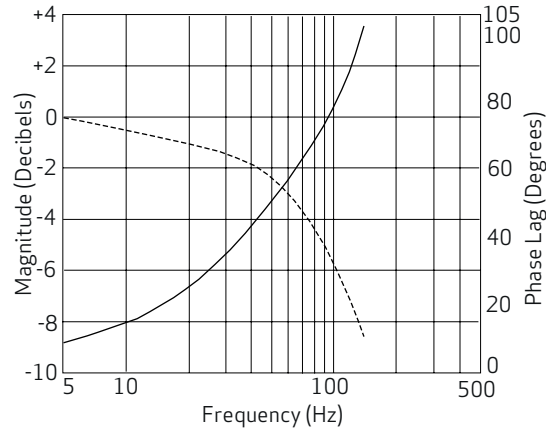

S57/S63..F

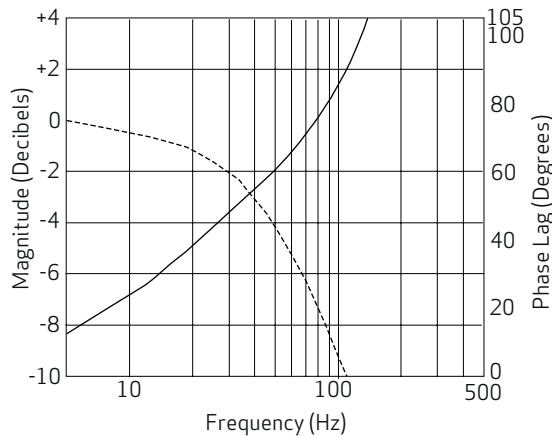

S57/S63..G

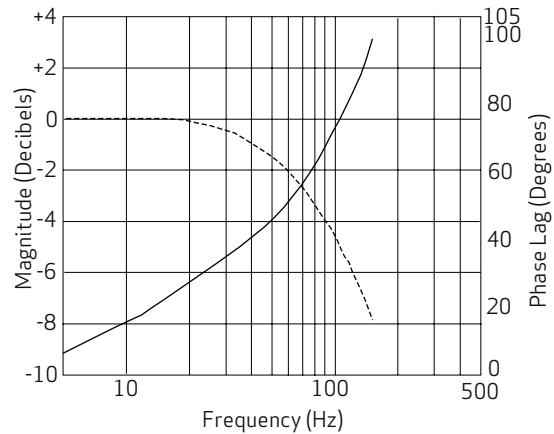

Measured with 40 % signal amplitude, at 3,000 psi (210 bar) pilot or operating pressure, fluid viscosity of 24 cSt, and fluid temperature of 104 °F (40 °C)



# HIGH RESPONSE

Preferred design for most position, pressure, or force control applications. Ensures a fast response time to meet system demands with a high level of accuracy. High flow pilot (G) is standard.

Type	-3 dB	90 deg phase lag	Step response
H00/01/02/04/10/19..F	120 Hz	200 Hz	4 ms
H00/01/02/04/10/19..G	140 Hz	230 Hz	3 ms
H38..F	90 Hz	130 Hz	7 ms
H38..G	120 Hz	170 Hz	5 ms

## Typical Characteristic Curves

H00/H01/H02/H04/H10/H19..F

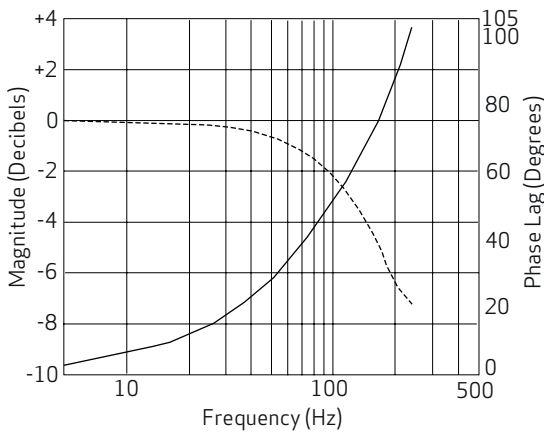

H00/H01/H02/H04/H10/H19..G

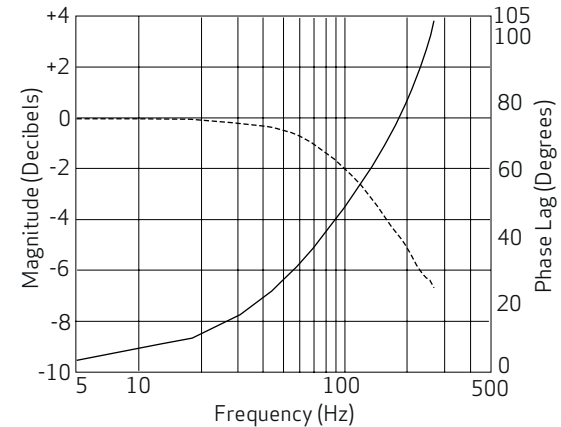

H38..F

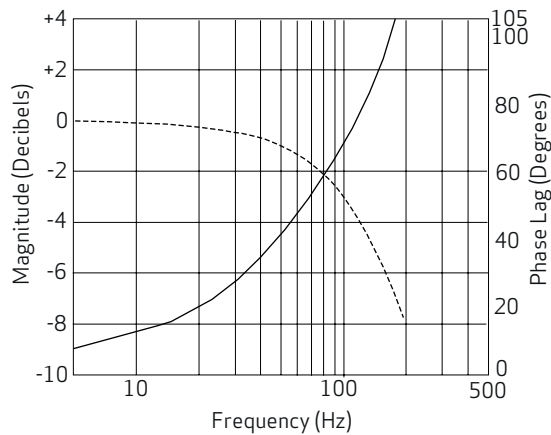

H38..G

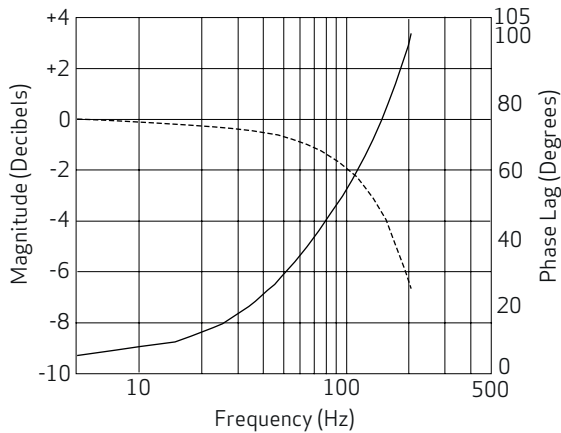

Measured with 40 % signal amplitude, at 3,000 psi (210 bar) pilot or operating pressure, fluid viscosity of 24 cSt, and fluid temperature of 104 °F (40 °C)

## VERY HIGH RESPONSE

Recommended for the most demanding applications. A smaller spool and high flow pilot (G) enables the valve to match demand at very high frequency.

Type	-3 dB	90 deg phase lag	Step response
V02/V04/V10/V19..G	400 Hz	330 Hz	2 ms
V02/V04/V10/V19..X	450 Hz	350 Hz	2 ms
V21/V29..G	350 Hz	280 Hz	4 ms

### Typical Characteristic Curves

V02/V04/V10/V19..G

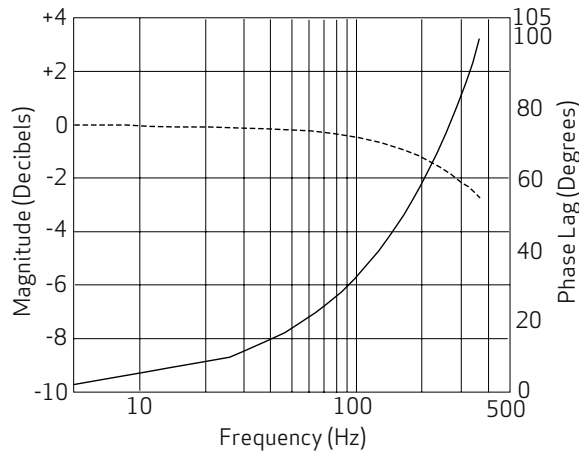

V02/V04/V10/V19..X <sup>1)</sup>

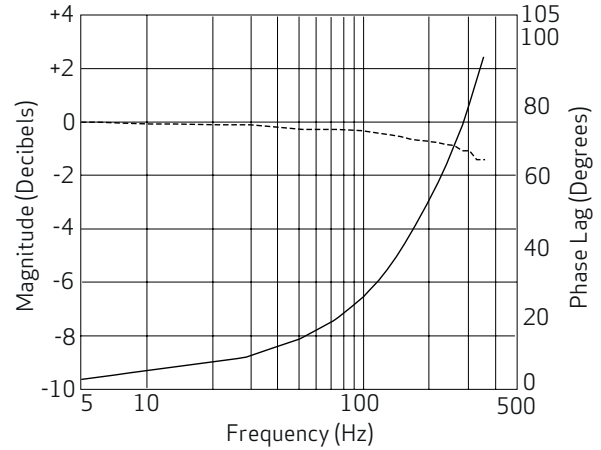

- 1) Contact Applications Engineering to confirm special pilot type (X). Type X can represent many non-standard configurations. This very high flow pilot can be used to improve response even further, but can limit maximum flow rate capability.

V21/V29..G

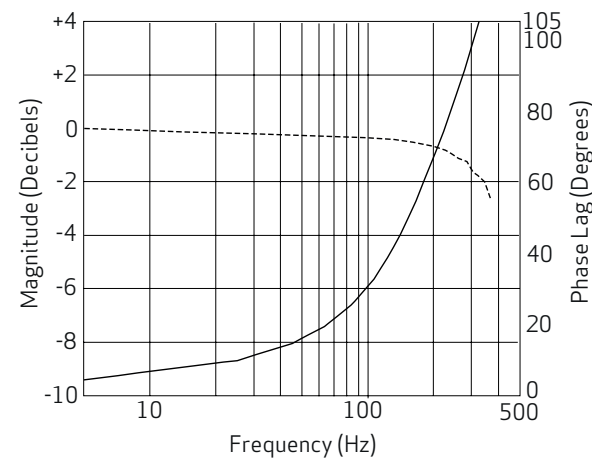

Measured with 40 % signal amplitude, at 3,000 psi (210 bar) pilot or operating pressure, fluid viscosity of 24 cSt, and fluid temperature of 104 °F (40 °C)

# INSTALLATION DRAWING

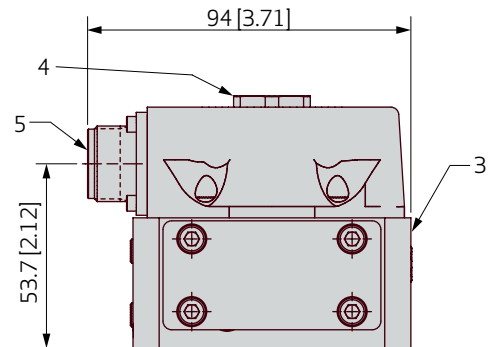
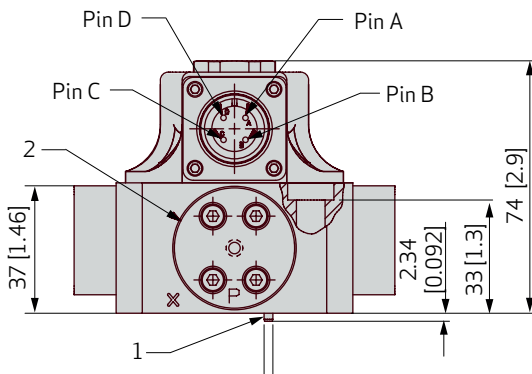
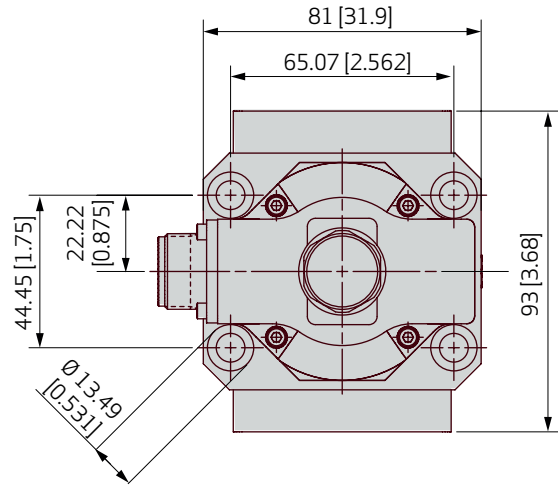
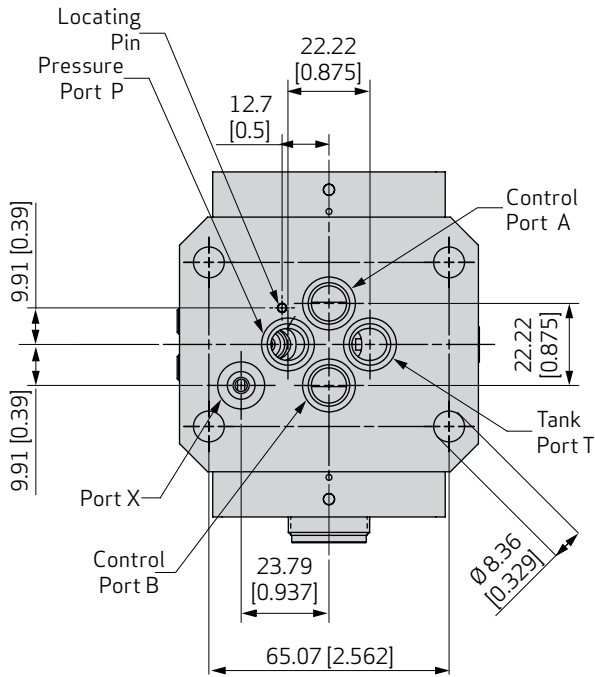

1. Location pin (refer to section 'Hole Pattern' for position)
2. Filter location (filter replacement see service manual)
3. Mechanical null adjust screw (requires 3/8" wrench and 3/32" hex key)
4. Optional magnetic null adjust (requires 7/8" wrench) (see manuals "G761" Moog P/N CDS6673 and "G761K/-761K intrinsically safe series" Moog P/N CDS6769)
5. Connector mates with MS3106F14S-2S (Moog P/N: -49054F014S002S)

## X Port Configuration

For operation with internal or external pilot connection

Pilot flow supply	Set screw (M3 internal hexagon socket, torque to 25 in-lb)	
	X	P
Internal P	Closed	Open
External X	Open	Closed

## MOUNTING REQUIREMENTS REF. ISO 10372-04-04-0-92 (PORT CIRCLE DIAMETER 0.875)

### Surface

Surface to which valve is mounted requires:

- Flatness of 0.025 mm (0.001 in) over 100 mm (3.94 in)
- Average finish  $R_a$  better than 0.8  $\mu\text{m}$  (0.000032 in)

### Ports

For maximum flow ports must be designed as follows:

- P, T, A, B with diameters of 8.2 mm (0.323 in)
- X with diameter of 5.0 mm (0.20 in)

### Recommended Mounting Seals

Standard o-rings, 90 +/- 5 durometer, compatible with the hydraulic fluid

MIL-R-83248 size -013 for P, A, B, T port

MIL-R-83248 size -012 for X port

See section 'Spare parts'

# ELECTRICAL CONNECTION

## Rated Current and Coil Resistance

A variety of coils are available for G761/-761 Series Servo Valves, which offer a wide choice of rated currents.

Standard ordering code <sup>1)</sup>	Command signal (mA)			Coil resistance [Ohms/coil at 25 °C (77 °F)] <sup>2)</sup>	Power consumption [W]			Coil inductance [H] measured at 50 Hz <sup>3)</sup>		
	Single coil	Series coil	Parallel coil		Single coil	Series coil	Parallel coil	Single coil	Series coil	Parallel coil
<b>4</b>	±8	±4	±8	1,000	0.064	0.032	3.2	9.7	2.6	
<b>H</b>	±15	±7.5	±15	206	0.046	0.023	0.72	2.2	0.59	
<b>L</b>	±40	±20	±40	80	0.128	0.064	0.22	0.66	0.18	
<b>M</b>	±50	±25	±50	80	0.20	0.10	0.22	0.66	0.18	
<b>Z</b>	±200	±100	±200	22	0.88	0.44	0.07	0.21	0.06	

- 1) Others optional
- 2) The resistance and inductance of standard coils are given below. The 2 coils in each Servo Valve are wound with equal turns giving a normal production tolerance on coil resistance of ±10 %. Copper magnet wire is used, so the coil resistance will vary significantly with temperature. The effects of coil resistance changes can be essentially eliminated through use of a current feedback servo amplifier having high output impedance.
- 3) Inductance is determined under pressurized operating conditions and is greatly influenced by back electromagnetic forces of the torque motor. These effects vary with most operating conditions, and vary greatly with signal frequencies above 100 Hz. The apparent coil inductance values given are determined at 50 Hz.

## Coil Connections

A 4-pin electrical connector that mates with an MS3106F14S-2S is standard. All 4 torque motor leads are available at the connector so that external connections can be made for series, parallel or single operation.

G761/-761 Series Servo Valves can be supplied on special order with other connectors or pigtail.

### Standard Configuration for Valve Opening P → B, A → T

Single

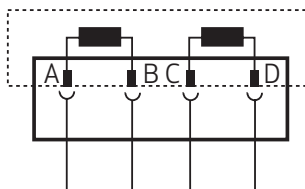

A (+), B (-) or C (+), D (-)

Series

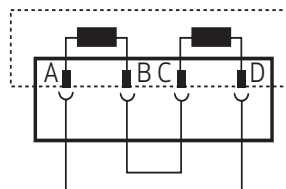

A (+), D (-), B and C connected

Parallel

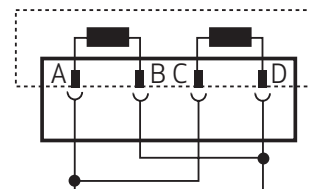

A and C (+), B and D (-)

# FLOW CALCULATION

The actual flow is dependent upon electrical command signal and valve pressure drop. The flow for a given valve pressure drop can be calculated using the square root function for sharp edge orifices.

$$Q = Q_N \cdot \sqrt{\frac{\Delta p}{\Delta p_N}}$$

- Q [l/min (gpm)]      Actual flow
- Q<sub>N</sub> [l/min (gpm)]      Rated flow
- Δp [bar (psi)]      Actual pressure drop per spool land
- Δp<sub>N</sub> [bar (psi)]      Rated pressure drop

## Flow Diagram for 4-way Operation

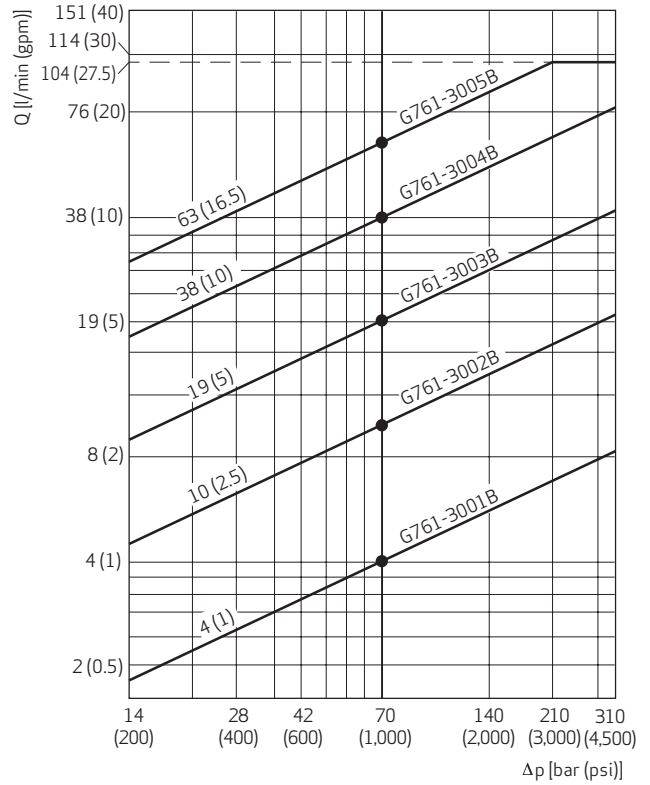

## Null-cut Options

Standard Axis Cut

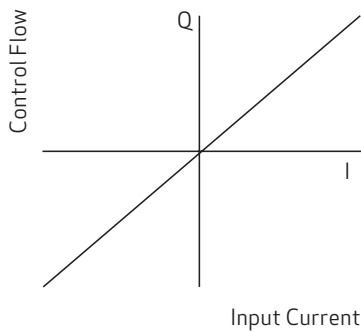

Minimal change in gain through null region. Best overall performance for most closed loop systems.

Underlap Spool

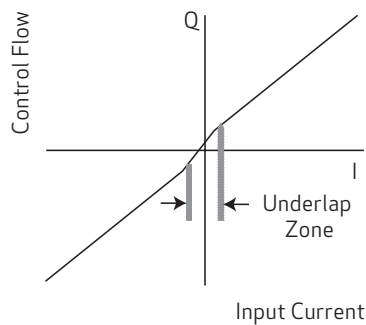

Null region flow gain is higher than normal. Always allows some small amount of flow past the spool.

Overlap Spool

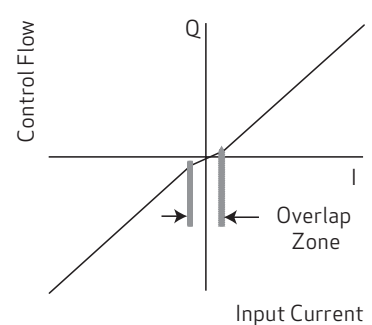

Null region flow gain is lower than normal. Spool types can range from minimal overlap to completely blocked flow.

## ACCESSORIES AND SPARE PARTS

### Spare Parts

Part name	Description	Material	Moog part number
Filter replacement kit	Contains the following: <ul style="list-style-type: none"> <li>• 2 pieces o-ring, inner Ø 3.7 mm (0.15 in) x Ø 1.8 mm (0.07 in)</li> <li>• 2 pieces o-ring, inner Ø 13 mm (0.51 in) x Ø 1.5 mm (0.06 in)</li> <li>• 1 piece filter disc 60 µm</li> </ul>	FKM 90 Shore	B52555RK201K001
		EPR 90 Shore	Upon request
O-ring for ports P, T, A, B	4 pieces, inner Ø 10.8 mm (0.43 in) x Ø 1.8 mm (0.07 in). Equivalent MIL-R-83248 size-013.	FKM 90 Shore	-42082-022
O-ring for port X	1 piece, inner Ø 9.3 mm (0.36 in) x Ø 1.8 mm (0.07 in). Equivalent MIL-R-83248 size-012.	FKM 90 Shore	-42082-013
Replaceable filter	60 µm nominal		A67999-065

### Accessories

Part name	Description	Remark	Moog part number
Mounting screws inch	4 pieces 5/16-18NC by 1.75 long, tightening torque 11 Nm (97 lbf in)	NAS1352N5-28 or equivalent	C66391-228B (not included with valve shipment)
Mounting screws metric	4 pieces M8x45 ISO 4762-10.9, tightening torque 11 Nm (97 lbf in)	NA0069A080045 or equivalent	B64929-008B045 (not included with valve shipment)
AMO manifold	Adjustable metering orifice manifold used to bleed fluid between A and B ports for better pressure control (O-rings and M8 x 1.25L mounting screws included)		-65568AM002
Flushing plate	Manifold employed in place of valve when initially cleaning hydraulic fluids (O-ring included)		-23718-001K002
Mating connector	4 pin electrical connector	MS3106F14S-2S	-49054F014S002S
	6 pin electrical connector	MS3106F14S-6S	-49054F014S006S
Mounting manifold	Base mounting manifold, 4 ports		-43586AM007
X port adapter	<ul style="list-style-type: none"> <li>• Moves x761 Series X port location to match -760 Series</li> <li>• Only required when converting -760 Series with external pilot to x761 Series</li> <li>• O-rings and 5/16-18 x 2.25L mounting screws included</li> </ul>		C74078AM001

## RELATED PRODUCTS

### DIN Rail Modules - Analog Control Cards

Moog's DIN rail mounted module analog control cards are ideal for use in enclosures where space is limited. Modules include servo amplifiers, transducer conditioning electronics, command and auxiliary function modules, valve drive amplifiers and power supplies. All of these modules are CE marked and require a 24 V<sub>DC</sub> supply. The modules mount to standard 35 mm DIN rail mount for easy installation and removal.

#### Portable Valve Testers - Evaluates Valves in the Field

Valve testers are a cost effective method for evaluating valves in the field. They provide a quick and easy means of differentiating between hydraulic and electronic problems.

There are five models to choose from, each with different levels of capability and flexibility to meet your specific requirements. All valve testers have a compact, easily portable design.

#### Mounting Manifolds - Easier Installation and Maintenance

Various mountings manifolds are available for standard industrial valves, including base and adapter types for mounting and flushing requirements. Other hardware such as bolts and connectors are also available.

The specific accessories you may need for a particular model are listed in the relevant product catalogs and can be ordered through your local office.

#### Filtration - Oil Filtration Requirements for Industrial Servo Systems

The most effective way to reduce life cycle costs of an oil hydraulic system is through close attention to contamination control.

For industrial servo systems with G761/-761 Series Servo Valves the ideal system filter arrangement is summarized as follows:

- Use a 10 micron (beta 10 → 75) high pressure filter without by-pass just before the valve or critical parts of the valve (e.g. pilot).
- Use a 5 micron (beta 5 → 75) low pressure filter in the return or bypass line.
- Use a filter in the tank breather that is at least the same filtration level as the finest filter in the system.

This recommendation is based on the fact that most servo and proportional valves can accept the odd particle up to 25 microns so the pressure filter will protect the valve from catastrophic failure. The real work is done by the low pressure filter reducing small particle contamination which is the prime contributor to component wear and silting.

Assuming that the filters are properly dimensioned and care is taken during initial installation and maintenance, the aim should be to limit oil contamination to ISO 4406 17/14/11.

For long life, the maximum levels are 15/13/10, respectively. It is important to note that these are maximum contamination levels and with proper care and regular filter change, significantly lower levels can and should be achieved. Attention must also be paid to a number of other factors that contribute to oil condition problems such as elevated temperatures, high tank humidity, "dirty" new oil.



## ABOUT MOOG

Moog Inc. is a worldwide designer, manufacturer and integrator of precision control components and systems. Moog's Industrial Systems Group designs and manufactures high performance motion control solutions combining electric, hydraulic, and hybrid technologies with expert consultative support in a range of applications including energy production and generation machinery, industrial production machinery and simulation and test equipment. We help performance-driven companies design and develop their next-generation machines. Moog Industrial Systems Group, with fiscal year 2020 sales of USD 909 million and over 40 locations worldwide, is part of Moog Inc. (NYSE: MOG.A and MOG.B) which has sales of USD 2.885 billion.

This vast scope ensures that our engineers remain close to the needs of machine builders and provide flexible design solutions and technical expertise tailored to our customers' toughest challenges.

Moog experts work in close collaboration with machine builders and application engineers to design motion control systems for greater productivity, higher reliability, superior connectivity, less costly maintenance and more effective operations. Our regional presence, industry knowledge and design flexibility ensure Moog motion control solutions are tailored to their environment - from meeting operating regulations and performance standards, to taking machine performance to a higher level.

### Products

At the heart of every Moog solution is an array of products engineered for precision, high performance and reliability. For more than six decades, Moog products have been specified for critical machine applications.

Some are developed specifically for unique operating environments. Others are standard equipment on machines across many industries. All are continuously improved to take advantage of the latest technology breakthroughs and advancements.

Moog products include:

- Servo Valves and Proportional Valves
- Servo Motors and Servo Drives
- Motion Controllers and Software
- Radial Piston Pumps
- Actuators
- Integrated Hydraulic Manifold Systems and Cartridge Valves
- Slip Rings
- Motion Bases

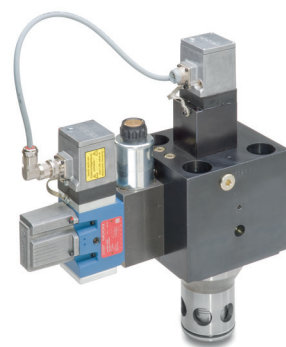
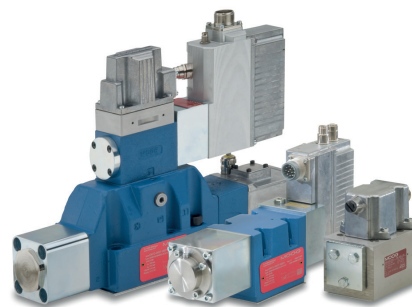
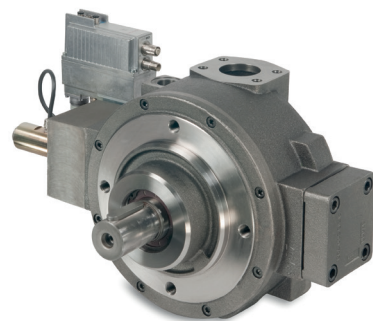

## ABOUT MOOG

### Hydraulic Solutions

Since Bill Moog invented the first commercially viable servo valve in 1951, Moog has set the standard for world-class hydraulic technology. Today, Moog products are used in a variety of applications - providing high power, enhanced productivity and ever better performance for some of the world's most demanding applications.

### Electric Solutions

Clean operation, low noise generation, less maintenance and reduced power consumption make Moog electric solutions ideal for applications worldwide. Moog is the ideal partner for applications where transitioning technologies require special expertise.

### Hybrid Solutions

By incorporating the advantages of existing hydraulic and electric technologies - including modular flexibility, increased efficiency and cleanliness - into innovative hybrid solutions, Moog offers new performance potential in specialized applications.



Flight Simulation



Formula One Simulation Table

## MOOG GLOBAL SUPPORT

Moog Global Support is our promise to offer world-class Repair and Maintenance Services delivered expertly by our trained technicians. With the reliability only available from a leading manufacturer with facilities around the world, Moog offers you service and expertise you can count on to keep your equipment operating as it should.

This promise offers many benefits to our customers including:

- Reduce your downtime by keeping critical machines running in peak performance
- Protect your investment by ensuring reliability, versatility and long-life of products
- Better plan your maintenance activities and make systematic upgrades
- Leverage our flexible programs to meet the unique service requirements of your facility

Look to Moog for global support including:

- Repair services using OEM parts are performed by trained technicians to the latest specifications

- Stock management of spare parts and products to prevent unplanned downtime
- Flexible programs, tailored to your needs such as upgrades, preventative maintenance and annual/multiyear contracts
- On-site services bring the expertise to you, providing quicker commissioning, set-up and diagnostics
- Access to reliable services that are guaranteed to offer consistent quality anywhere in the world For more information on Moog Global Support visit [www.moog.com/industrial/service](http://www.moog.com/industrial/service).



# ORDERING CODE

**Model number (assigned at the factory)**

**Type designation**

G761/-761

1 2 3 4 5 6 7 8 9 10 11

**Optional features**

-	Series specification
K	Intrinsically safe

**Model ascension number (factory assigned)**

**Model revision (factory assigned)**

**1 Valve version**

<b>S</b>	Standard response
<b>H</b>	High response
<b>V</b>	Super High response

**2 Rated flow**

For  $\Delta p_N = 35$  bar (500 psi) per spool land

	l/min	(gpm)	Response
<b>00</b>	0.5	(0.13)	H/V
<b>01</b>	1	(0.25)	H/V
<b>02</b>	2	(0.5)	H/V
<b>04</b>	4	(1.0)	H/V
<b>10</b>	10	(2.5)	S/H/V
<b>19</b>	19	(5.0)	S/H/V
<b>29</b>	29	(7.5)	S/H/V
<b>38</b>	38	(10.0)	S/H
<b>57</b>	57	(15.0)	S
<b>63</b>	63	(16.5)	S
<b>75</b>	75	(19.5)	S

**3 Maximum operating pressure [bar (psi)] and body material**

<b>J</b>	315	(4,500)	aluminum
<b>K</b>	350	(5,000)	steel

**4 Bushing/spool design<sup>1)</sup>**

<b>O</b>	4-way: axis cut, zero lap
<b>C</b>	4-way: minimal overlap only, reduced tolerance
<b>A</b>	4-way: 3% overlap
<b>D</b>	4-way: 10% overlap
<b>B</b>	3-way only, port A active. Port B vented to return
	Others upon request

**11 Special features-contact factory**

<b>V</b>	Vented cap
<b>N</b>	Magnetic null
<b>R</b>	Reverse polarity

**10 Command signal for 100% spool stroke**

	Single or parallel coil value	Series coil value
<b>4</b>	± 8 mA	± 4 mA
<b>H</b>	± 15 mA	± 7.5 mA
<b>L</b>	± 40 mA	± 20 mA
<b>M</b>	± 50 mA	± 25 mA
<b>Z</b>	± 200 mA	± 100 mA

**9 Valve connector**

<b>P</b>	4 pin MS threaded connector over P-side
<b>B</b>	4 pin MS threaded connector over B-side
<b>A</b>	4 pin MS threaded connector over A-side
<b>T</b>	4 pin MS threaded connector over T-side
<b>U</b>	6 pin MS threaded connector over P-side
<b>2</b>	4 lead pigtail connector over A-side
<b>3</b>	4 lead pigtail connector over P-side

**8 Seal material**

<b>V</b>	FKM (fluorocarbon)
<b>E</b>	EPR (ethylene-propylene copolymer)

**7 Pilot connections (field configurable)**

<b>4</b>	Internal supply (port P)
<b>5</b>	External supply (port X)

**6 Spool position without electrical signal**

<b>M</b>	Center position
<b>A</b>	Port A open to return
<b>B</b>	Port B open to return

**5 Pilot stage design (assigned by Moog)**

<b>F</b>	Standard dynamics
<b>G</b>	High dynamics

Note: Other options available upon request (X and Y are wildcards)

<sup>1)</sup> Dual gain and asymmetrical flow are available in special configuration (see section "Null Cut Options")

**Preferred Models**

Model number	Type designation	Rated flow		Rated current mA
		l/min	gpm	
G761-3001B	H04JOFM4VPL	4	1.0	± 40
G761-3002B	H10JOFM4VPL	10	2.5	± 40
G761-3003B	H19JOGM4VPL	19	5.0	± 40
G761-3004B	H38JOGM4VPL	38	10.0	± 40
G761-3005B	S63JOGM4VPL	63	16.5	± 40

# MORE PRODUCTS. MORE SUPPORT.

Moog designs a range of motion control products to complement those featured in this document. Moog also provides service and support for all of our products. For more information, contact the Moog facility closest to you.

Australia  
+61 3 9561 6044  
Service + 61 3 8545 2140  
info.australia@moog.com  
service.australia@moog.com

India  
+91 80 4057 6666  
Service +91 80 4057 6604  
info.india@moog.com  
service.india@moog.com

Russia  
+7 8 31 713 1811  
Service +7 8 31 764 5540  
info.russia@moog.com  
service.russia@moog.com

Brazil  
+55 11 3572 0400  
info.brazil@moog.com  
service.brazil@moog.com

Ireland  
+353 21 451 9000  
info.ireland@moog.com

Singapore  
+65 677 36238  
Service +65 651 37889  
info.singapore@moog.com  
service.singapore@moog.com

Canada  
+1 716 652 2000  
info.canada@moog.com

Italy  
+39 0332 421 111  
Service 800 815 692  
info.italy@moog.com  
service.italy@moog.com

South Africa  
+27 12 653 6768  
info.southafrica@moog.com

China  
+86 21 2893 1600  
Service +86 21 2893 1626  
info.china@moog.com  
service.china@moog.com

Japan  
+81 46 355 3767  
info.japan@moog.com  
service.japan@moog.com

Spain  
+34 902 133 240  
info.spain@moog.com

France  
+33 1 4560 7000  
Service +33 1 4560 7015  
info.france@moog.com  
service.france@moog.com

Korea  
+82 31 764 6711  
info.korea@moog.com  
service.korea@moog.com

Sweden  
+46 31 680 060  
info.sweden@moog.com

Germany  
+49 7031 622 0  
Service +49 7031 622 197  
info.germany@moog.com  
service.germany@moog.com

Luxembourg  
+352 40 46 401  
info.luxembourg@moog.com

Turkey  
+90 216 663 6020  
info.turkey@moog.com

Hong Kong  
+852 2 635 3200  
info.hongkong@moog.com

The Netherlands  
+31 252 462 000  
info.thenetherlands@moog.com  
service.netherlands@moog.com

United Kingdom  
+44 (0) 1684 858000  
Service +44 (0) 1684 278369  
info.uk@moog.com  
service.uk@moog.com

USA  
+1 716 652 2000  
info.usa@moog.com  
service.usa@moog.com

For product information, visit [www.moog.com/industrial](http://www.moog.com/industrial)  
For service information, visit [www.moogglobalsupport.com](http://www.moogglobalsupport.com)

Moog is a registered trademark of Moog Inc. and its subsidiaries.  
All trademarks as indicated herein are the property of Moog Inc. and its subsidiaries.  
©2021 Moog Inc. All rights reserved. All changes are reserved.

Flow Control Valve with Analog Interface, G761/-761 Series, ISO 10372 Size 4  
KEM/Rev. L, September 2021, CDL6642-en